

THERMODYNAMIC STEAM TRAP

SU2N/SU2H

USER'S MANUAL

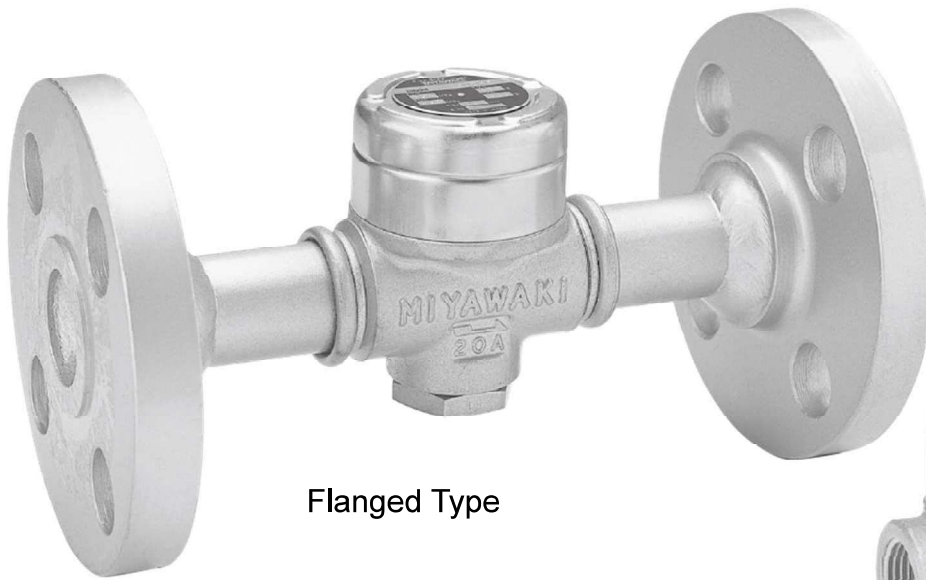

Flanged Type



Screwed Type



Socket Weld Type

 **MIYAWAKI INC.**

SAFETY GUIDE

The models SU2N and SU2H are medium and high-pressure disc-type steam traps equipped with an automatic blow-off mechanism.

In order to get maximum benefit from this product, be sure to read this manual before installing it.

The following warnings and cautions are shown at appropriate places in this manual.



Failure to observe this type of precaution may lead to serious injury or death.



Failure to follow this type of precaution can lead to injury or damage to equipment and property.

Table of Contents

1	SPECIFICATIONS AND MARKINGS	1
2	CONSTRUCTION DETAILS	2
3	INSTALLATION	3
4	OPERATION	4
5	MAINTENANCE	5
6	TROUBLESHOOTING	8
7	WARRANTY	9
8	SERIAL NUMBER (S. No.) DESIGNATION	10
9	GUIDANCE FOR READING SPECIAL PRODUCT NAME	11

1 SPECIFICATIONS AND MARKINGS



WARNING

Be sure not to use this product at higher pressures than the specified maximum allowable pressure (PMA) or at temperatures higher than the specified maximum allowable temperature (TMA).

The following items are displayed on the name plate or the side of the product.

Check each item to avoid misuse of the product.

- 1) Maximum allowable pressure (PMA): 6.4 MPa (928 psig)
 - 2) Maximum allowable temperature (TMA): 425 °C (797 °F)
 - 3) Maximum Operating pressure (PMO): SU2N - 4.6 MPa (667 psig)
SU2H – 6.4 MPa (928 psig)
 - 4) Maximum operating temperature (TMO): 425 °C (797 °F)
 - 5) Size: 15 mm (1/2”), 20 mm (3/4”) or 25 mm (1”)
 - 6) Year of production: The two leftmost digits in the four-digit or nine-digit “S. No.” on the name plate are the last two digits of the year of production.
 - 7) Flow direction: Shown by an arrow
 - 8) Body material: Stainless Steel SUS420J2
(Flanged type: Flanges and pipes are carbon steel.)
(Socket Weld Type: The joint components are carbon steel.)
 - 9) Model symbol: Showing the product model name
- Some pictures and illustrations in this manual are examples of SU2(N/H) models. For more details regarding dimensions and other specifications, please refer to the catalog.

The models SU2N & SU2H fully comply with the requirements of the European Pressure Equipment Directive 2014/68/EU. They are classified according to Article 4, Section 3 of the PED, which does not allow to bear the CE marking.

2 CONSTRUCTION DETAILS

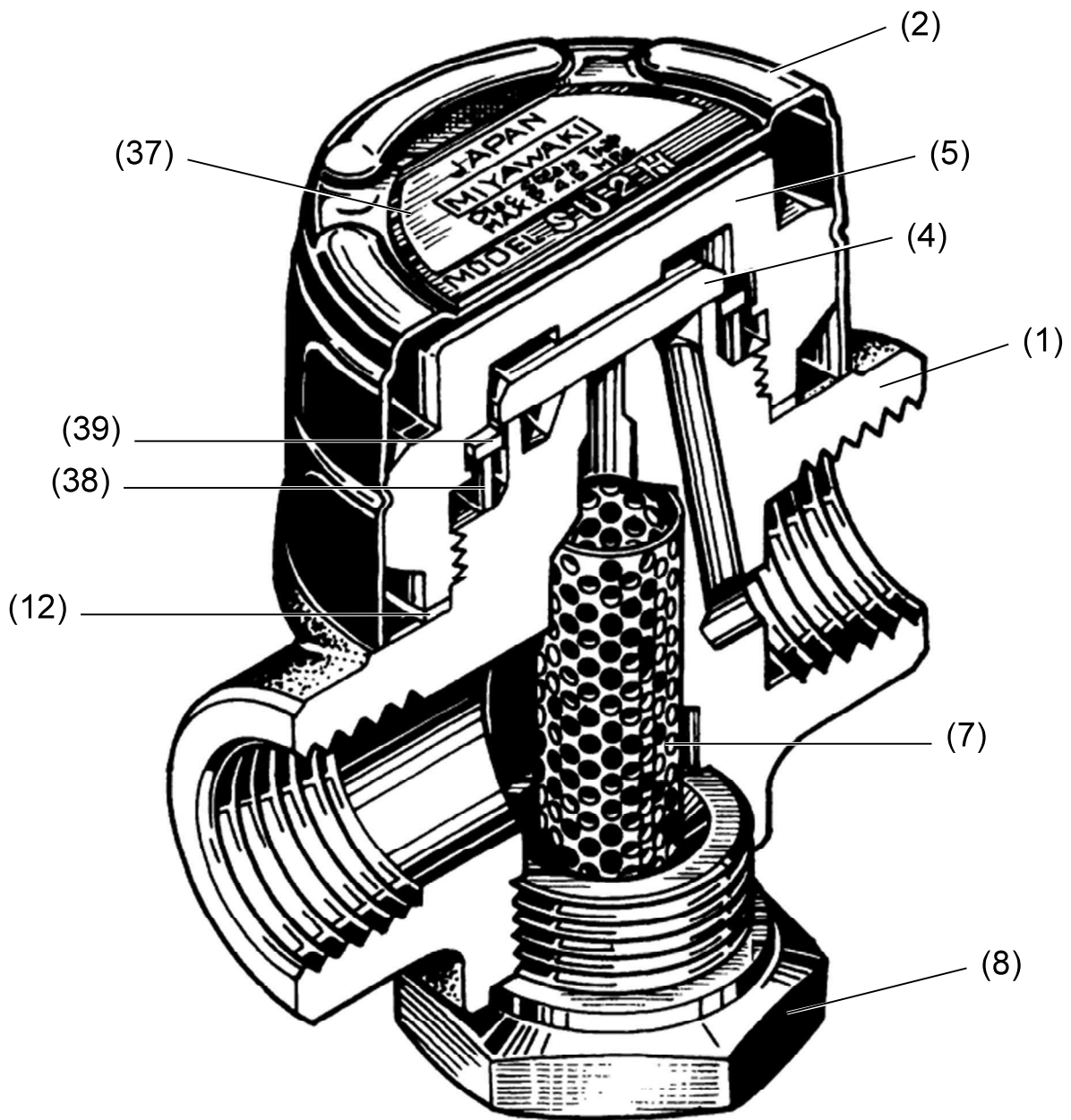

-
- | | |
|-----------|------------------|
| 1. Body | 8. Plug |
| 2. Cover | 12. Cap Gasket |
| 4. Disc | 37. Name Plate |
| 5. Cap | 38. Bimetal |
| 7. Screen | 39. Stopper Ring |

3 INSTALLATION



WARNING

Pay very careful attention when working in hazardous environments. There is a risk of explosion and the possibility of dangerous gases leaking. Always check whether the pipeline contains flammable, high pressure or high temperature materials before starting to work.

- Make sure that isolation valves are installed on both the upstream and downstream lines.



CAUTION

Before installing the product, open both isolation valves and the bypass valve, if one exists, to blow out any debris or dirt inside the pipeline. After blowing out the line, before starting to work, close the isolation valves and allow time for the temperature to drop to a safe working temperature.

When installing the product, be sure to leave clearance for maintaining it.

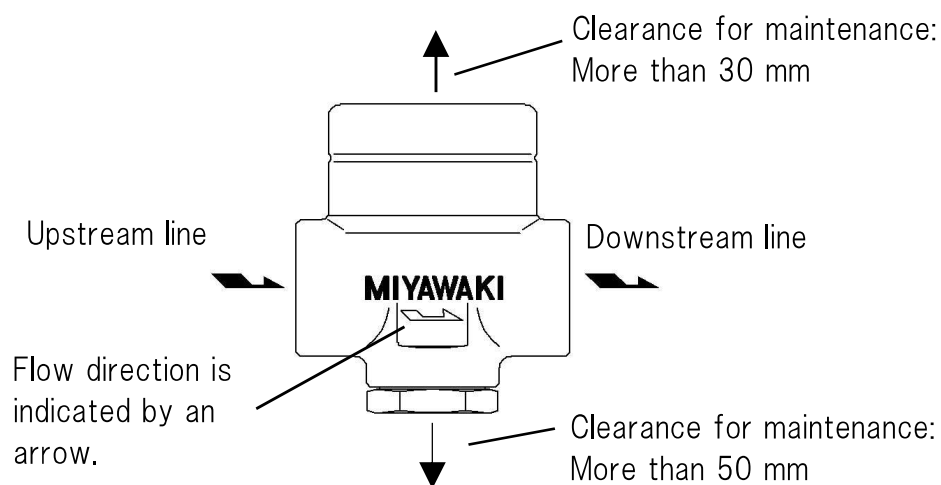

- 1) Remove the dustproof seals covering both connections.
※Products shipped in plastic bags may not have dustproof seals.
- 2) Check the flow direction indicated on the side of the body.
- 3) The models SU2N and SU2H can be used for both horizontal and vertical lines. However, when installing the models in a horizontal line, be sure to maintain a slight slope to the line, so that any condensate will flow smoothly.
- 4) Open the isolation valve on the upstream line and make sure the product works normally.

4 OPERATION



CAUTION

Before starting operation, open the bypass valve or blow valve completely and blow off the scale in the piping.

4.1 Operation procedure

- 1) After blowing off the scale from the piping, close the bypass valve or blow valve.
- 2) Open the stop valve on the trap outlet side.
- 3) Open the stop valve on the trap inlet side.

4.2 Stop procedure

- 1) Close the stop valve on the trap inlet side.
- 2) Close the stop valve on the trap outlet side.

* When stopping for a long time, completely drain the condensate from the piping and trap and close the valves before and after the trap.

5 MAINTENANCE



WARNING

- Before removing the trap from the pipe or disassembling it, be sure to close the isolation valves. Then, release the residual pressure from the trap body (make sure that the pressure in the main body is equal to the atmospheric pressure). After it has fully cooled down (after the temperature of the main body has reached ambient temperature), confirm for safe conditions and then begin work.
- Even when the isolation valves are closed, there may be residual internal pressure due to leaks from the isolation valves. Therefore, be very careful.



CAUTION

- When replacing parts, make sure the replacement parts are supplied by MIYAWAKI.

The performance of steam traps deteriorates gradually over time due to wear, corrosion or dirt accumulating around the valve and the valve seat. Please conduct periodic diagnosis of traps in order to keep steam control systems and equipment working well.

5.1 Tools for Diagnosis Steam Traps

■ Dr. Trap

Dr. Trap is a sophisticated steam trap management system for diagnosing steam traps automatically by measuring the vibration and temperature of the steam trap. Survey results are stored in the testing equipment and transferred to a steam trap analysis software. The software aggregates and analyses steam trap survey data, identifying faulty steam traps, providing steam loss and financial loss data, estimating CO₂ emissions corresponding to leaking steam traps and providing many other analyze possibilities to manage the steam trap population easily.

■ Dr. Trap Jr.

Dr. Trap Jr. is an inexpensive and easily to handle steam trap diagnostic system consisting of an ultrasonic checker, temperature probe and a sophisticated analysis software. The software allows to determine the condition of a steam trap, to estimate steam and financial losses and the related CO₂ emissions.

For more details, please, check our homepage:

<https://www.miyawaki.net/en/products/steam-trap-management-system>

or ask our local representative.

5.2 Repairs

When a trap fails, it is necessary to clean the internal parts and to replace damaged parts. Take the failed trap apart following the steps below.

5.2.1 Disassembling the trap

- 1) Remove the cover (2). *Use a flat-blade screwdriver to remove the cover.
- 2) Remove the cap (5) by turning it counterclockwise.
- 3) Remove the disc (4), the stopper ring (39), the bimetal (38), and the cap gasket (12).

5.2.2 Disassembling the screen

- 1) Turn the plug (8) counterclockwise and remove it.
- 2) Then remove the screen (7).

After cleaning the trap and replacing damaged parts, reassemble the parts in reverse order as follows.

5.2.3 Reassembling the screen

- 1) Put the screen (7) back on the plug (8).
- 2) Tighten the plug (8) with the screen to the body (1).

5.2.4 Reassembling the trap

- 1) Reinstall the cap gasket (12) on the body (1).
*When reassembling, never fail to replace the cap gasket (12) with a new one.
- 2) Reinstall the bimetal (38) and the stopper ring (39) on the body (1).
- 3) Put the disc (4) on the seat surface in the body (1).
*The groove of the disc should point to the seat of the trap.
- 4) Fasten the cap (5).
- 5) Put the cover (2) on the cap (5).

Torque table

Parts	Tools	Across the flats	Torque
Cap (5)	Torque wrench	46 mm (1.81")	150 N·m
Plug (8)	Torque wrench	29 mm (1.14")	80 N·m

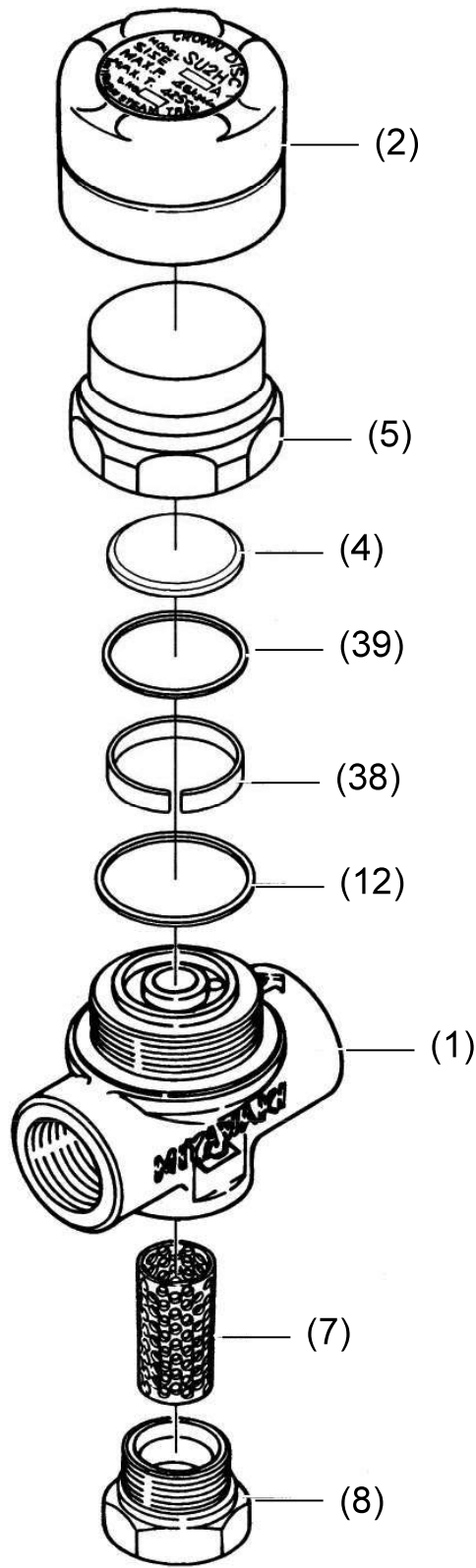

- 1. Body
- 2. Cover
- 4. Disc
- 5. Cap
- 7. Screen
- 8. Plug
- 12. Cap Gasket
- 37. Name Plate
- 38. Bimetal
- 39. Stopper Ring

6 TROUBLESHOOTING

Problem		Possible cause	Solution
Steam leaks or blows through.		Dirt is stuck around the disc (4) or seat.	Clean the disc (4) and the seat.
		Damage, wear or corrosion of the disc (4).	Replace the damaged part. *1
		Damage, wear or corrosion of the seat.	Replace the damaged part. *2
		The back pressure is too high. (The back pressure of the SU2N or SU2H must be less than 50% of the inlet pressure.)	Replace the trap with an appropriate trap.
Steam leaks from the body.	From the cap connection	The cap (5) is loose.	Tighten the cap (5). *3
		The cap gasket (12) is damaged.	Replace the cap gasket (12).
		The sealing surface of the body (1) and/or cap (5) are damaged.	Replace the cap or the steam trap to a new one.
	From the plug connection	The plug (8) is loose.	Tighten the plug (8). *4
		The sealing surface of the body (1) or plug (8) is damaged.	Replace the damaged part.
Insufficient condensate discharged, or no condensate discharged.		The screen (7) is clogged.	Clean the screen (7).
		Dirt has built up around the seat.	Clean the seat.
		The bimetal (38) is damaged.	Replace the bimetal (38).
		Wrong installation direction	Reinstall the product in the correct direction.
		Insufficient condensate capacity.	Replace the trap with a larger capacity trap.

*1 and *2: The seat surfaces of the disc and body are lapped to fit each other precisely. Therefore, when replacing either the disc or the body, replace them as a pair.

*3 and *4: Refer to the torque table in Section 5, "Maintenance" to retighten the parts with the correct torque.

7 WARRANTY

7.1 Warranty period

The warranty period is 18 months after shipment or 12 months after installation, whichever occurs first.

7.2 Details of the warranty

If the product stops working correctly within the warranty period, we will repair or replace the product free of charge if the cause of the trouble is not one of the following items.

- 1) The precautions described in this manual were not observed.
- 2) User's errors or mistakes such as an inappropriate installation or incorrect handling, or an excessively large impact caused by dropping
- 3) Problems caused by devices or equipment other than MIYAWAKI's, or a disallowed use environment
- 4) When a repair or modification has been performed by anyone other than MIYAWAKI or people who are authorized to make such repairs
- 5) Intrusion of salt or other substances that promote significant rust or corrosion or problems from fluids that contain the same substances
- 6) Consumable parts such as Packing, Gasket, O-ring, Diaphragm, etc.
- 7) Attachment or accumulation of foreign matter in the pipe, such as dust and scale
- 8) Problems from fires, natural disasters, or other force majeure which is not MIYAWAKI's responsibility

6.3 Warranty limitation

The remedy available under the warranty shall not exceed the sales price of the products delivered, for any cause whatsoever.

8 SERIAL NUMBER (S. No.) DESIGNATION

The following 4-digit or 9-digit “S. No.” is displayed on the product.

- For 4-digit display

S.No. □□□□

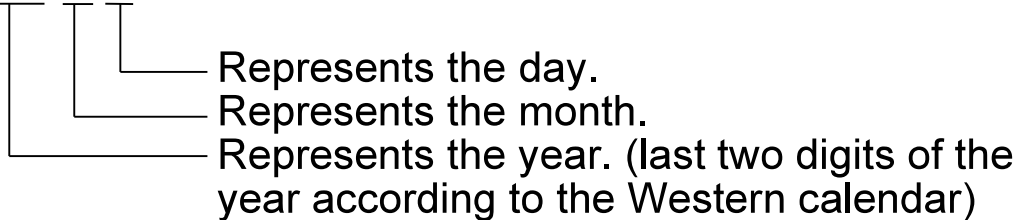

Example of serial number designation

1 7 1 1 → Jan. 1, 2017

2 9 X M → Oct. 21, 2029

- For 9-digit display

S.No. □□□□□□□□□

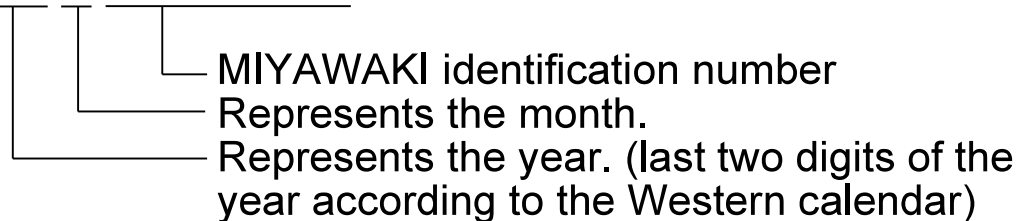

Example of serial number designation

1 7 1 1 2 C 0 2 0 → Jan., 2017

2 9 X 0 5 M 0 5 0 → Oct., 2029

Month designation system

Month	1	2	3	4	5	6	7	8	9	10	11	12
Symbol	1	2	3	4	5	6	7	8	9	X	Y	Z

Day designation system

Day	1	2	3	4	5	6	7	8	9	10	11	12
Symbol	1	2	3	4	5	6	7	8	9	A	B	C

Day	13	14	15	16	17	18	19	20	21	22	23	24
Symbol	D	E	F	G	H	J	K	L	M	N	O	P

Day	25	26	27	28	29	30	31
Symbol	Q	R	S	T	U	V	W

9 GUIDANCE FOR READING SPECIAL PRODUCT NAME

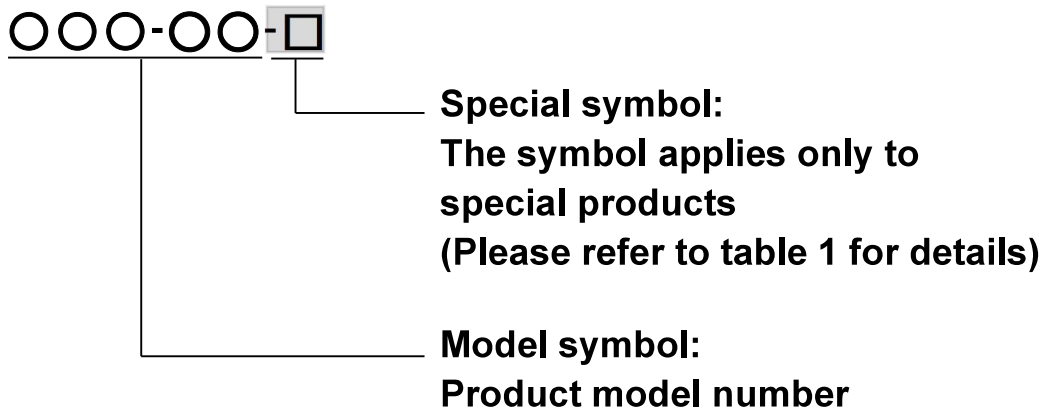

Table 1 Symbol description

Suffix	Special contents
A	Trap for high-pressure gas installed property (only for Gas Trap)
C	Blow valve attached
K	Change of gasket
L	Special face to face dimension
M	Change of parts material
P, T	Change of operating pressure, temperature, condensate capacity, etc.
R	Change of screen mesh
V	Change of air vent
X	Other than mentioned above or complex of special contents above

- © 2020 MIYAWAKI INC.

This user's manual may not be reproduced or copied in whole or in part, without the written consent of MIYAWAKI INC.

- Some special specifications of the product you have, may found to be different from the ones in the user's manual. If you have any question, please contact MIYAWAKI, our local authorized agent, or the company where you purchased the product.
 - In the interest of the development and improvement of our products, MIYAWAKI Inc. reserves the right to change the specification of the products without prior notice.
-



INTERNATIONAL SALES DEPT.

2-1-30, Tagawakita, Yodogawa-ku, Osaka, 532-0021, Japan

Tel: +81-6-6302-5549

www.miyawaki.net e-mail: export@miyawaki-inc.co.jp

EU Importer and Authorized representative:



Birnbaumsmühle 65, 15234 Frankfurt (Oder), Germany

Tel: +49-335-4007-0097

www.miyawaki.net e-mail: info@miyawaki.de

China Importer and Authorized representative:



Room 902, Building 8, Huaqing Chuangzhi Park, No.3 Qingyan Road, Huishan District,
Wuxi City Jiangsu Province, China

Tel: +86-510-8359-5125

www.miyawaki-inc.com.cn e-mail: mywkwest@miyawaki-inc.com.cn

808027-05 2303
SU2N/SU2H