

INVERTED BUCKET STEAM TRAP

ES8N

USER'S MANUAL



 **MIYAWAKI INC.**

SAFETY GUIDE

The model ES8N is a ductile cast iron inverted bucket steam trap for small up to medium condensate loads.

In order to get maximum benefit from this product, be sure to read this manual before installing it.

The following warnings and cautions are shown at appropriate places in this manual.



Failure to observe this type of precaution may lead to serious injury or death.



Failure to follow this type of precaution can lead to injury or damage to equipment and property.

Table of Contents

1	SPECIFICATIONS AND MARKINGS	1
2	CONSTRUCTION DETAILS	2
3	INSTALLATION	3
4	OPERATION	5
5	MAINTENANCE	6
6	TROUBLESHOOTING	10
7	WARRANTY	11
8	SERIAL NUMBER (S. No.) DESIGNATION	12
9	GUIDANCE FOR READING SPECIAL PRODUCT NAME	13

1 SPECIFICATIONS AND MARKINGS



WARNING

Be sure not to use this product at higher pressures than the specified maximum allowable pressure (PMA) or at temperatures higher than the specified maximum allowable temperature (TMA).

Check the operating characteristics to avoid misuse of the product.

- 1) Maximum allowable pressure (PMA): 1.6 MPa (232 psig)
 - 2) Maximum allowable temperature (TMA): 350 °C (662 °F)
 - 3) Maximum operating pressure (PMO): ES8N-5 : 0.5 MPa (73 psig)
(Shown as MAX.P. on the name plate) ES8N-8 : 0.8 MPa (116 psig)
ES8N-16 : 1.6 MPa (232 psig)
 - 4) Maximum operating temperature (TMO): 350 °C (662 °F)
(Shown as MAX.T. on the name plate)
 - 5) Size: 15 mm (1/2"), 20 mm (3/4"), 25 mm (1")
 - 6) Year of production: The two leftmost digits in the four-digit or nine-digit 'S. No.' are the last two digits of the year of production (see remarks on page 12).
 - 7) Flow direction: Shown by an arrow
 - 8) Body material: Ductile cast iron FCD450
 - 9) Model : Showing the product model name
- Some pictures and illustrations in this manual are examples of ES8N models. For more details regarding dimensions and other specifications, please refer to the catalog.

The model ES8N fully complies with the requirements of the European Pressure Equipment Directive 2014/68/EU. It is classified according to Article 4, Section 3 of the PED, which does not allow to bear the CE marking.

2 CONSTRUCTION DETAILS

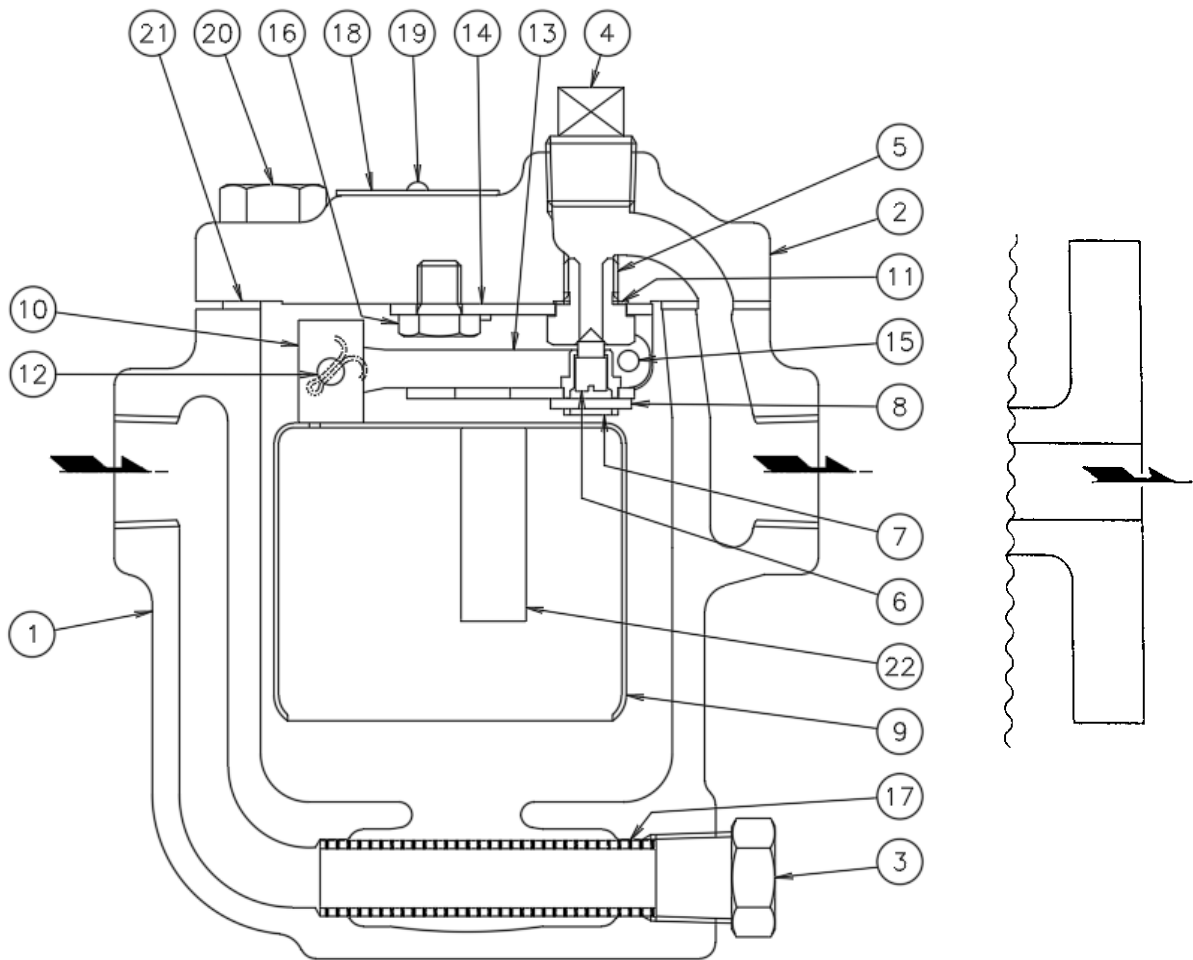

-
- | | | |
|-----------------|-----------------|------------------|
| 1. Body | 9. Bucket | 16. Set Bolt |
| 2. Cover | 10. Eyebolt | 17. Screen |
| 3. Plug | 11. Seat Gasket | 18. Name Plate |
| 4. Plug | 12. Eyebolt Pin | 19. Rivet |
| 5. Valve Seat | Split Pin | 20. Cover Bolt |
| 6. Valve | 13. Lever | 21. Cover Gasket |
| 7. Valve Holder | 14. Bracket | 22. Weight |
| 8. Pin | 15. Pin | |

3 INSTALLATION



WARNING

Pay very careful attention when working in hazardous environments. There is a risk of explosion and the possibility of dangerous gases leaking. Always check whether the pipeline contains flammable, high pressure or high temperature materials before starting to work.

- Make sure that isolation valves are installed on both the upstream and downstream lines.



CAUTION

Before installing the product, open both isolation valves and the bypass valve, if one exists, to blow out any debris or dirt inside the pipeline. After blowing out the line, before starting to work, close the isolation valves and allow time for the temperature to drop to a safe working temperature.

When installing the product, be sure to leave clearance for maintaining it.

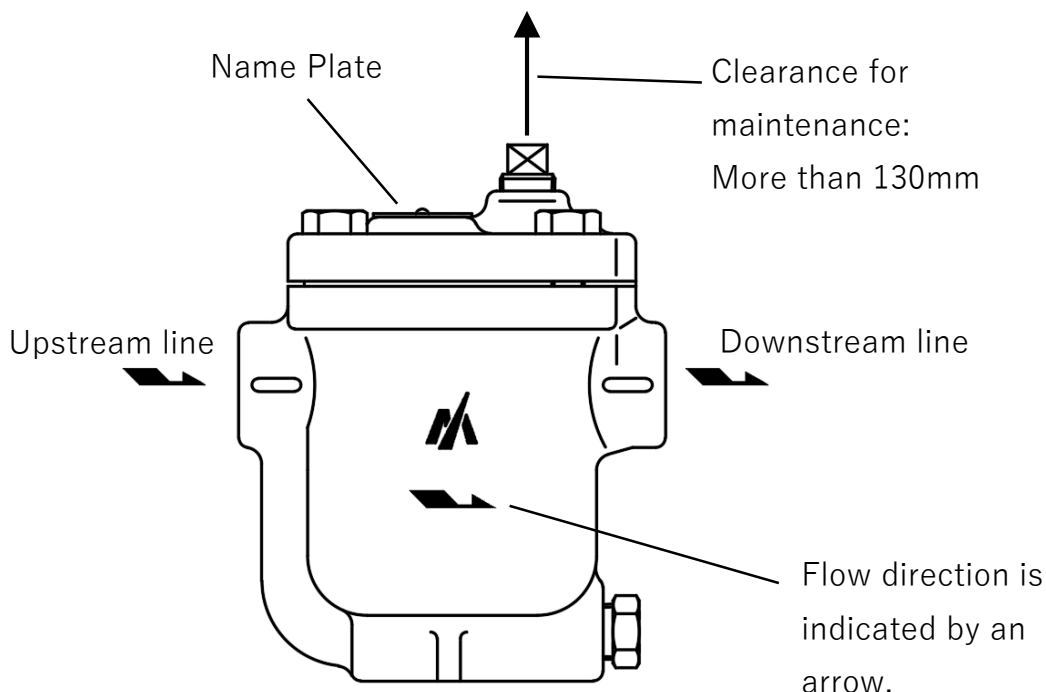

- 1) Remove the dustproof seals covering both connections.
 ※Products shipped in plastic bags may not have dustproof seals.
 - 2) Check the flow direction indicated on the body.
 - 3) When installing the model ES8N, install it so that the flow from the upstream line to the downstream line is horizontal and the name plate is on the top side of the body. When installing the trap in a horizontal line, be sure to maintain a slight slope of the line, so that any condensate will flow smoothly to the trap.
 - 4) Open the isolation valve on the upstream line slowly and make sure the product works normally.
- ※ Install the trap at a lower position than the equipment that generates condensate.
- ※ If the trap is installed higher than the steam using equipment, please install a lift fitting as shown in Drawing B for better performance.

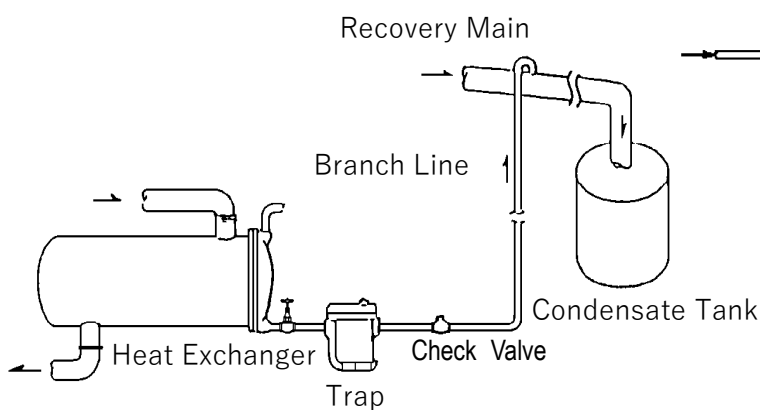

Drawing A

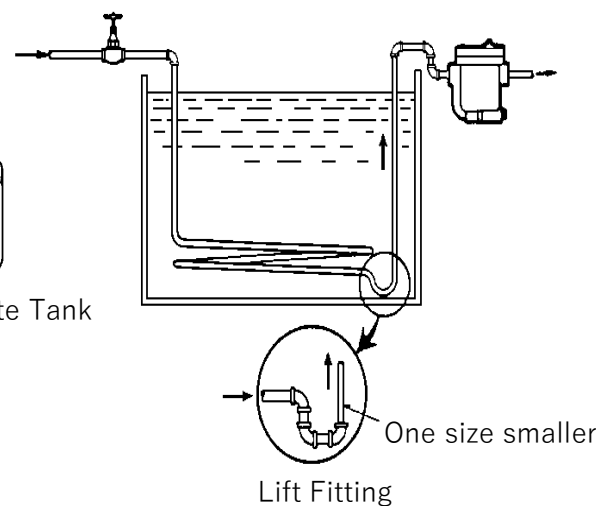

Drawing B

⚠ CAUTION

If installed on a cylinder dryer, please install lower than the lowest point of the cylinder and minimize the horizontal piping.

4 OPERATION



CAUTION

Before starting operation, open the bypass valve or blow valve completely and blow off the scale in the piping.

4.1 Operation procedure

- 1) After blowing off the scale from the piping, close the bypass valve or blow valve.
- 2) Open the stop valve on the trap outlet side.
- 3) Open the stop valve on the trap inlet side.

4.2 Stop procedure

- 1) Close the stop valve on the trap inlet side.
- 2) Close the stop valve on the trap outlet side.

* When stopping for a long time, completely drain the condensate from the piping and trap and close the valves before and after the trap.

5 MAINTENANCE



WARNING

- Before removing the trap from the pipe or disassembling it, be sure to close the isolation valves. Then, release the residual pressure from the trap body (make sure that the pressure in the main body is equal to the atmospheric pressure). After it has fully cooled down (after the temperature of the main body has reached ambient temperature), confirm for safe conditions and then begin to work.
- Even when the isolation valves are closed, there may be residual internal pressure due to leaks from the isolation valves. Therefore, be very careful.



CAUTION

- When replacing parts, make sure the replacement parts are supplied by MIYAWAKI.

The performance of steam traps deteriorates gradually over time due to wear, corrosion or dirt accumulating around the valve and the valve seat. Please conduct periodic diagnosis of traps in order to keep steam control systems and equipment working well.

5.1 Tools for Diagnosing Steam Traps

■ Dr. Trap

Dr. Trap is a sophisticated steam trap management system for diagnosing steam traps automatically by measuring the vibration and temperature of the steam trap. Survey results are stored in the testing equipment and transferred to a steam trap analysis software. The software aggregates and analyses steam trap survey data, identifying faulty steam traps, providing steam loss and financial loss data, estimating CO₂ emissions corresponding to leaking steam traps and providing many other analyze possibilities to manage the steam trap population easily.

■ Dr. Trap Jr.

Dr. Trap Jr. is an inexpensive and easily to handle steam trap diagnostic system consisting of an ultrasonic checker, temperature probe and a sophisticated analysis software. The software allows to determine the condition of a steam trap, to estimate steam and financial losses and the related CO₂ emissions.

For more details, please, check our homepage:

<https://www.miyawaki.net/en/products/steam-trap-management-system>

or ask our local representative.

5.2 Repairs

When a trap fails, it is necessary to clean the internal parts and to replace damaged parts. Take the failed trap apart following the steps below.

5.2.1 Disassembling the trap

- 1) Untighten the plug (3), take out the screen (17), check and clean it.
- 2) Remove the cover bolts (20) and remove the cover (2) from the body (1).
- 3) The internal unit and bucket (9) can be removed while connected to the cover (2). (See Drawing C)
- 4) When the pin (15) has been pulled out, the valve (6), valve holder (7), pin (8), bucket (9), eyebolt (10), eyebolt pin (12) and lever (13) can be removed together from the cover (2). (See Drawing D)
- 5) Take off the pin (8). The valve (6) and valve holder (7) come apart from the lever (13).
※ Basically, there is no need to disassemble the unit as the valve unit can be purchased as a complete unit. But, if you disassemble the parts, replace the pin (8) with a new one.
- 6) Remove the cover gasket (21) and clean the sealing surfaces of the body (1) and cover (2).



CAUTION

Clean the body (1) and cover (2) with care not to damage the sealing surface. Scratches on the sealing surface may cause steam leakage.

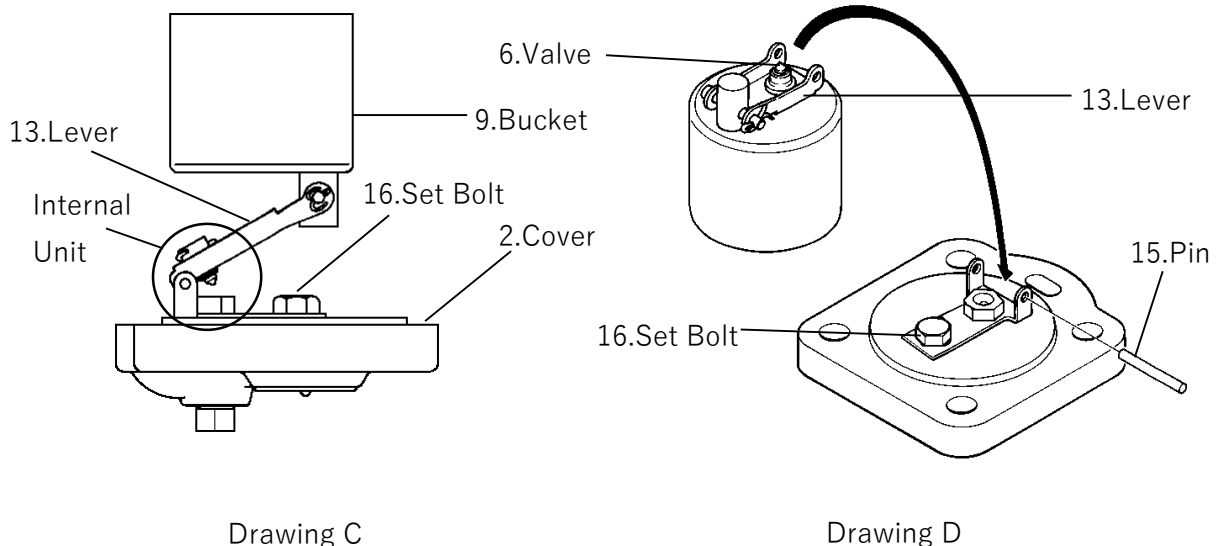

Take appropriate measures according to “6. Troubleshooting”. After cleaning the trap and replacing damaged parts, re-assemble the parts in reverse order as follows. Refer to the torque table for each part.

5.2.2 Reassembling the trap

- 1) Attach the valve holder (7) to the lever (13), insert the valve (6) into the valve holder (7), and attach the pin (8) to the valve holder (7).
After bending the tip of the pin (8), check that the valve holder (7) can be rotated 360° lightly.
- 2) Connect the internal unit removed from the cover (2) to the cover with the pin (15).
- 3) If there are loose threads on the internal unit, be sure to tighten them.
- 4) Place the cover gasket (21) on the sealing surface of the body (1). At this time, be careful not to displace the outlet passage hole of the cover gasket (21) and the body (1).
- 5) Install the cover (2) with the internal unit on the body (1) and tighten the cover bolts (20). At this time, be careful that the outlet passage holes in the body (1) and cover (2) do not shift.
- 6) Put the screen (17) into the plug (3) and tighten the plug.

Torque table

Parts	Tools	Across the flats	Torque
Valve Seat (5)	Torque wrench	14 mm (0.55")	18 N·m
Set Bolt (16)	Torque wrench	13 mm (0.51")	11 N·m
Cover Bolt (20)	Torque wrench	17 mm (0.67")	21 N·m



CAUTION

When reassembling always replace the cover gasket (21) with a new one. Tighten the cover bolts (20) evenly crosswise.

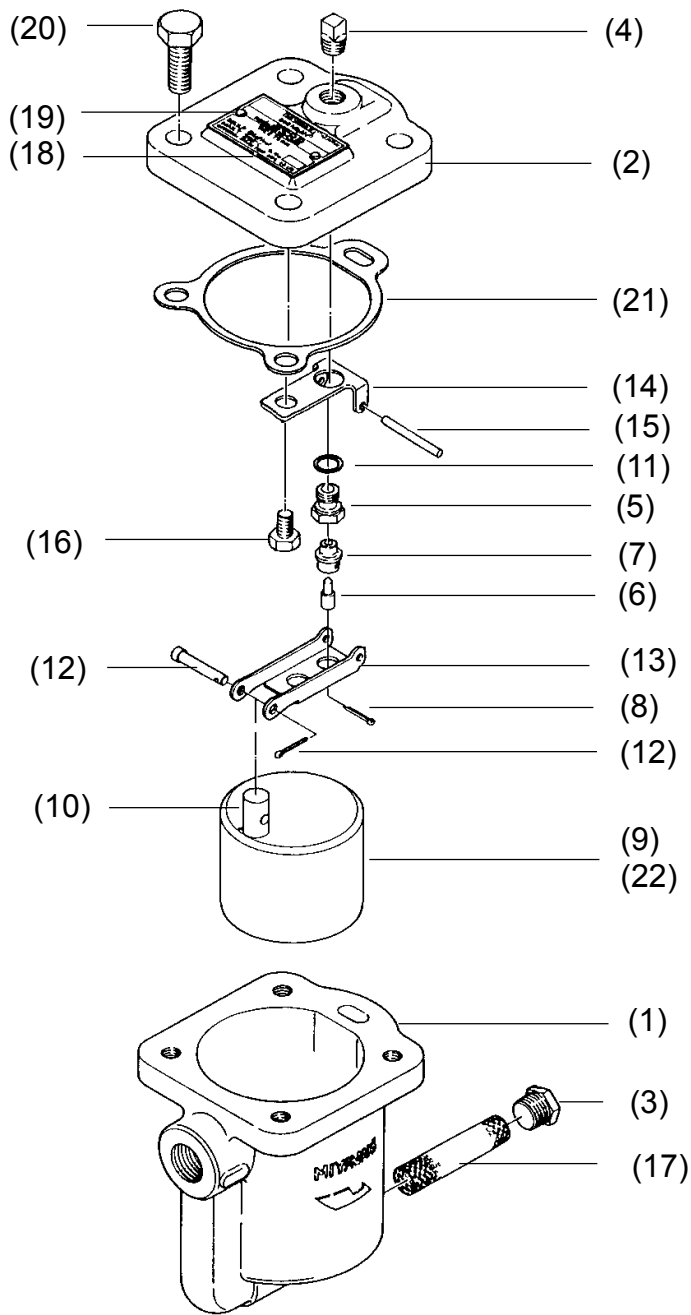

1. Body
2. Cover
3. Plug
4. Plug
5. Valve Seat
6. Valve
7. Valve Holder
8. Pin
9. Bucket
10. Eyebolt
11. Seat Gasket
12. Eyebolt Pin
Split Pin
13. Lever
14. Bracket
15. Pin
16. Set Bolt
17. Screen
18. Name Plate
19. Rivet
20. Cover Bolt
21. Cover Gasket
22. Weight

6 TROUBLESHOOTING

Problem		Possible cause	Solution
Steam leaks or blows through.		The condensate amount in the body (1) is extremely small, and the valve opening state continues due to the sinking of the bucket (9).	Remove the plug (4) and pour water into the body (1).
		A foreign object is caught between the valve (6) and the valve seat (5).	Disassemble and clean the valve (6) and valve seat (5). *1
		The valve (6) and valve seat (5) are damaged.	Replace the valve unit with a new one.
		The bucket (9) has dropped out with the valve open.	Disassemble and install the bucket (9) correctly.
Steam leaks from the body.	From the connection between the body and cover	The cover bolts (20) are loose.	Tighten the cover bolts (20). *2
		The cover gasket (21) is damaged.	Replace the cover gasket (21).
Insufficient condensate discharged, or no condensate discharged.		Steam pressure exceeds the trap specification.	Reduce steam pressure or replace with high pressure trap.
		Insufficient condensate capacity.	Replace the trap with a larger capacity trap.
		Plugged air vent hole in the bucket (9).	Clean the air vent hole in the bucket (9).
		Dirt has built up on or around the valve seat (5).	Clean the valve seat (5).
		The bucket (9) has dropped out with the valve close.	Disassemble and install the bucket (9) correctly.

*1 and *2: Refer to the torque table in Section 5, "Maintenance" to retighten the parts with the correct torque.

7 WARRANTY

7.1 Warranty period

The warranty period is 18 months after shipment or 12 months after installation, whichever occurs first.

7.2 Details of the warranty

If the product stops working correctly within the warranty period, we will repair or replace the product free of charge if the cause of the trouble is not one of the following items.

- 1) The precautions described in this manual were not observed.
- 2) User's errors or mistakes such as an inappropriate installation or incorrect handling, or an excessively large impact caused by dropping
- 3) Problems caused by devices or equipment other than MIYAWAKI's, or a disallowed use environment
- 4) When a repair or modification has been performed by anyone other than MIYAWAKI or people who are authorized to make such repairs
- 5) Intrusion of salt or other substances that promote significant rust or corrosion or problems from fluids that contain the same substances
- 6) Consumable parts such as Packing, Gasket, O-ring, Diaphragm, etc.
- 7) Attachment or accumulation of foreign matter in the pipe, such as dust and scale
- 8) Problems from fires, natural disasters, or other force majeure which is not MIYAWAKI's responsibility

7.3 Warranty limitation

The remedy available under the warranty shall not exceed the sales price of the products delivered, for any cause whatsoever.

8 SERIAL NUMBER (S. No.) DESIGNATION

The following 4-digit or 9-digit 'S.No.' is displayed on the product.

- For 4-digit display

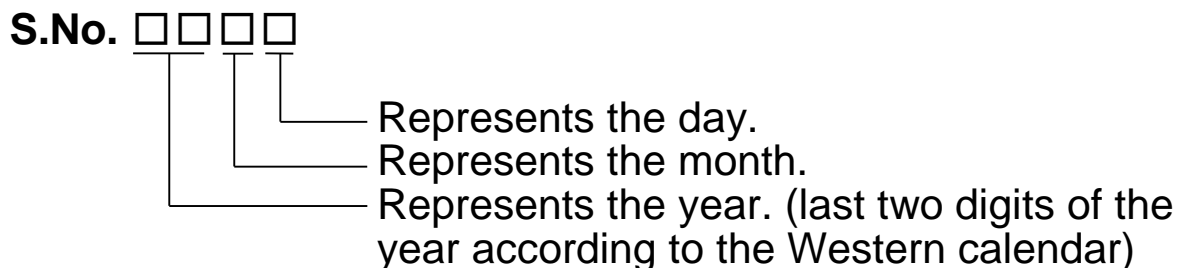

Example of serial number designation

1 7 1 1 → Jan.1, 2017

2 9 X M → Oct. 21, 2029

- For 9-digit display

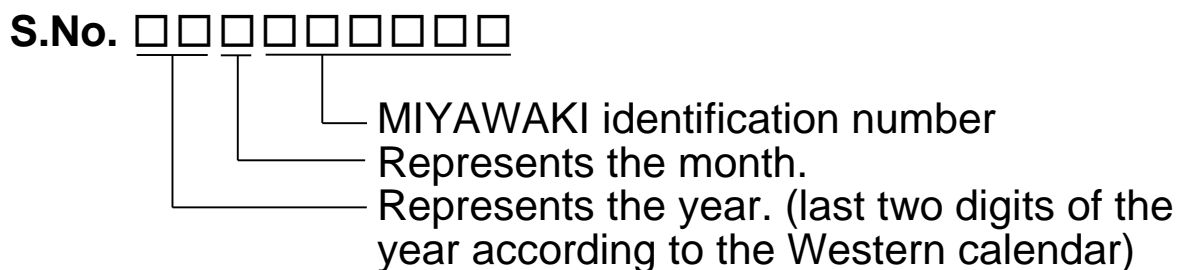

Example of serial number designation

1 7 1 1 2 C 0 2 0 → Jan., 2017

2 9 X 0 5 M 0 5 0 → Oct., 2029

Month designation system

Month	1	2	3	4	5	6	7	8	9	10	11	12
Symbol	1	2	3	4	5	6	7	8	9	X	Y	Z

Day designation system

Day	1	2	3	4	5	6	7	8	9	10	11	12
Symbol	1	2	3	4	5	6	7	8	9	A	B	C

Day	13	14	15	16	17	18	19	20	21	22	23	24
Symbol	D	E	F	G	H	J	K	L	M	N	O	P

Day	25	26	27	28	29	30	31
Symbol	Q	R	S	T	U	V	W

9 GUIDANCE FOR READING SPECIAL PRODUCT NAME

○○○-○○-□

Special symbol:
 The symbol applies only to special products
 (Please refer to table 1 for details)

Model symbol:
 Product model number

Table 1 Symbol description

Suffix	Special contents
A	Trap for high-pressure gas installed property (only for Gas Trap)
C	Blow valve attached
K	Change of gasket
L	Special face to face dimension
M	Change of parts material
P, T	Change of operating pressure, temperature, condensate capacity, etc
R	Change of screen mesh
V	Change of air vent
X	Other than mentioned above or complex of special contents above

-
- お買い上げの製品及びこの取扱説明書内容についてのご質問は下記にお問い合わせください。また、この取扱説明書を紛失したり、汚損により読めなくなった場合は、同じく下記へご請求ください。
 - 特殊仕様の製品については、取扱説明書の内容と一部異なる場合があります。特殊仕様に関する取扱説明書内容についてのご質問は、お買い上げ頂いた販売店若しくは最寄の弊社ミヤワキまでお問い合わせください。
 - 外観及び仕様などは、製品改良のため予告なしに一部変更させて頂くことがあります。

- © 2020 MIYAWAKI INC.

This user's manual may not be reproduced or copied in whole or in part, without the written consent of MIYAWAKI INC.

- Some special specifications of the product may found to be different from the ones in the user's manual. If you have any question, please contact MIYAWAKI, our local authorized agent, or the company where you purchased the product.
 - In the interest of the development and improvement of our products, MIYAWAKI Inc. reserves the right to change the specification of the products without prior notice.
-



お問い合わせ窓口

製品の使い方やアフターサポートなど、製品に関するお問い合わせは、右のQRコードから、最寄りの弊社事業所までご連絡ください。弊社事業所一覧(連絡先)は右のQRコードをスマートフォン、携帯電話等で読み取っていただくことでアクセスできます。



本社・工場

〒532-0021 大阪市淀川区田川北 2-1-30

Tel : 06-6302-5531(代)

www.miyawaki-inc.com



INTERNATIONAL SALES DEPT.

2-1-30, Tagawakita, Yodogawa-ku, Osaka, 532-0021, Japan

Tel: +81-6-6302-5549

www.miyawaki.net e-mail: export@miyawaki-inc.co.jp

EU Importer and Authorized representative:



MIYAWAKI GmbH

Birnbaumsmühle 65, 15234 Frankfurt (Oder), Germany

Tel: +49-335-4007-0097

www.miyawaki.net e-mail: info@miyawaki.de

China Importer and Authorized representative:



MIYAWAKI WEST Co., Ltd.

Room 1705, No.1, Building No.311, Yanxin Road, Huishan Economic Development Zone, Wuxi, Jiangsu, China

Tel: +86-510-8359-5125

www.miyawaki-inc.com.cn e-mail: mywkwest@miyawaki-inc.com.cn

808072-05 2010

ES8N